

IRF7509

HEXFET® Power MOSFET

- Generation V Technology
- Ultra Low On-Resistance
- Dual N and P Channel MOSFET
- Very Small SOIC Package
- Low Profile (<1.1mm)
- Available in Tape & Reel
- Fast Switching

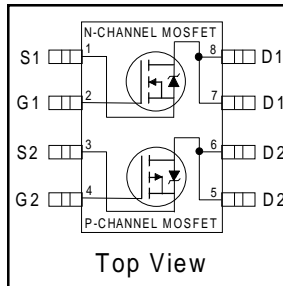

	N-Ch	P-Ch
V_{DS}	30V	-30V
$R_{DS(on)}$	0.11 Ω	0.20 Ω

Description

Fifth Generation HEXFETs from International Rectifier utilize advanced processing techniques to achieve extremely low on-resistance per silicon area. This benefit, combined with the fast switching speed and ruggedized device design that HEXFET Power MOSFETs are well known for, provides the designer with an extremely efficient and reliable device for use in a wide variety of applications.

The new Micro8 package, with half the footprint area of the standard SO-8, provides the smallest footprint available in an SOIC outline. This makes the Micro8 an ideal device for applications where printed circuit board space is at a premium. The low profile (<1.1mm) of the Micro8 will allow it to fit easily into extremely thin application environments such as portable electronics and PCMCIA cards.

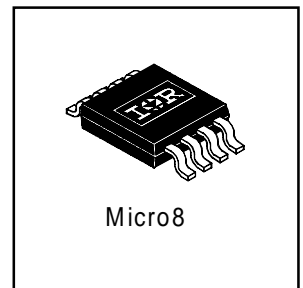

Absolute Maximum Ratings

	Parameter	Max.		Units
		N-Channel	P-Channel	
V_{DS}	Drain-Source Voltage	30	-30	V
$I_D @ T_A = 25^\circ\text{C}$	Continuous Drain Current, V_{GS}	2.7	-2.0	A
$I_D @ T_A = 70^\circ\text{C}$	Continuous Drain Current, V_{GS}	2.1	-1.6	
I_{DM}	Pulsed Drain Current①	21	-16	
$P_D @ T_A = 25^\circ\text{C}$	Maximum Power Dissipation④	1.25		W
$P_D @ T_A = 70^\circ\text{C}$	Maximum Power Dissipation④	0.8		W
	Linear Derating Factor	10		mW/°C
V_{GS}	Gate-to-Source Voltage	± 20		V
V_{GSM}	Gate-to-Source Voltage Single Pulse $t_p < 10\mu\text{s}$	30		V
dv/dt	Peak Diode Recovery dv/dt ②	5.0		V/ns
T_J, T_{STG}	Junction and Storage Temperature Range	-55 to + 150		°C
	Soldering Temperature, for 10 seconds	240 (1.6mm from case)		

Thermal Resistance

	Parameter	Max.	Units
$R_{\theta JA}$	Maximum Junction-to-Ambient ④	100	°C/W

Electrical Characteristics @ T_J = 25°C (unless otherwise specified)

Parameter	Description	N-Ch	P-Ch	Min.	Typ.	Max.	Units	Conditions
V _{(BR)DSS}	Drain-to-Source Breakdown Voltage	N-Ch	30	—	—	—	V	V _{GS} = 0V, I _D = 250μA
		P-Ch	-30	—	—	—		V _{GS} = 0V, I _D = -250μA
ΔV _{(BR)DSS} /ΔT _J	Breakdown Voltage Temp. Coefficient	N-Ch	—	0.059	—	—	V/°C	Reference to 25°C, I _D = 1mA
		P-Ch	—	-0.039	—	—		Reference to 25°C, I _D = -1mA
R _{DS(ON)}	Static Drain-to-Source On-Resistance	N-Ch	—	0.09	0.110	—	Ω	V _{GS} = 10V, I _D = 1.7A ④
			—	0.14	0.175	—		V _{GS} = 4.5V, I _D = 0.85A ④
		P-Ch	—	0.17	0.20	—		V _{GS} = -10V, I _D = -1.2A ④
			—	0.30	0.40	—		V _{GS} = -4.5V, I _D = -0.6A ④
V _{GS(th)}	Gate Threshold Voltage	N-Ch	1.0	—	—	V	V _{DS} = V _{GS} , I _D = 250μA	
		P-Ch	-1.0	—	—		V _{DS} = V _{GS} , I _D = -250μA	
g _{fs}	Forward Transconductance	N-Ch	1.9	—	—	S	V _{DS} = 10V, I _D = 0.85A ④	
		P-Ch	0.92	—	—		V _{DS} = -10V, I _D = -0.6A ④	
I _{DSS}	Drain-to-Source Leakage Current	N-Ch	—	—	1.0	μA	V _{DS} = 24V, V _{GS} = 0V	
		P-Ch	—	—	-1.0		V _{DS} = -24V, V _{GS} = 0V	
		N-Ch	—	—	25		V _{DS} = 24V, V _{GS} = 0V, T _J = 125°C	
		P-Ch	—	—	-25		V _{DS} = -24V, V _{GS} = 0V, T _J = 125°C	
I _{GSS}	Gate-to-Source Forward Leakage	N-P	—	—	±100		V _{GS} = ± 20V	
Q _g	Total Gate Charge	N-Ch	—	7.8	12	nC	N-Channel I _D = 1.7A, V _{DS} = 24V, V _{GS} = 10V ④	
		P-Ch	—	7.5	11			
Q _{gs}	Gate-to-Source Charge	N-Ch	—	1.2	1.8	nC	P-Channel I _D = -1.2A, V _{DS} = -24V, V _{GS} = -10V ④	
		P-Ch	—	1.3	1.9			
Q _{gd}	Gate-to-Drain ("Miller") Charge	N-Ch	—	2.5	3.8	nC	P-Channel I _D = -1.2A, V _{DS} = -24V, V _{GS} = -10V ④	
		P-Ch	—	2.5	3.7			
t _{d(on)}	Turn-On Delay Time	N-Ch	—	4.7	—	ns	N-Channel V _{DD} = 15V, I _D = 1.7A, R _G = 6.1Ω, R _D = 8.7Ω ④	
P-Ch	—	9.7	—					
t _r	Rise Time	N-Ch	—	10	—	ns	P-Channel V _{DD} = -15V, I _D = -1.2A, R _G = 6.2Ω, R _D = 12Ω ④	
		P-Ch	—	12	—			
t _{d(off)}	Turn-Off Delay Time	N-Ch	—	12	—	ns	P-Channel V _{DD} = -15V, I _D = -1.2A, R _G = 6.2Ω, R _D = 12Ω ④	
		P-Ch	—	19	—			
t _f	Fall Time	N-Ch	—	5.3	—	ns	P-Channel V _{DD} = -15V, I _D = -1.2A, R _G = 6.2Ω, R _D = 12Ω ④	
		P-Ch	—	9.3	—			
C _{iSS}	Input Capacitance	N-Ch	—	210	—	pF	N-Channel V _{GS} = 0V, V _{DS} = 25V, f = 1.0MHz ③	
		P-Ch	—	180	—			
C _{oss}	Output Capacitance	N-Ch	—	80	—	pF	P-Channel V _{GS} = 0V, V _{DS} = -25V, f = 1.0MHz ③	
		P-Ch	—	87	—			
C _{rSS}	Reverse Transfer Capacitance	N-Ch	—	32	—	pF	P-Channel V _{GS} = 0V, V _{DS} = -25V, f = 1.0MHz ③	
		P-Ch	—	42	—			

Source-Drain Ratings and Characteristics

Parameter	Description	N-Ch	P-Ch	Min.	Typ.	Max.	Units	Conditions
I _S	Continuous Source Current (Body Diode)	N-Ch	—	—	—	1.25	A	
		P-Ch	—	—	—	-1.25		
I _{SM}	Pulsed Source Current (Body Diode) ①	N-Ch	—	—	—	21	A	
		P-Ch	—	—	—	-16		
V _{SD}	Diode Forward Voltage	N-Ch	—	—	—	1.2	V	T _J = 25°C, I _S = 1.7A, V _{GS} = 0V ③
		P-Ch	—	—	—	-1.2		T _J = 25°C, I _S = -1.8A, V _{GS} = 0V ③
t _{rr}	Reverse Recovery Time	N-Ch	—	40	60	ns	N-Channel T _J = 25°C, I _F = 1.7A, di/dt = 100A/μs ③	
		P-Ch	—	30	45			
Q _{rr}	Reverse Recovery Charge	N-Ch	—	48	72	nC	P-Channel T _J = 25°C, I _F = -1.2A, di/dt = -100A/μs ③	
		P-Ch	—	37	55			

Notes:

- ① Repetitive rating; pulse width limited by max. junction temperature. (See fig. 21)
- ② N-Channel I_{SD} ≤ 1.7A, di/dt ≤ 120A/μs, V_{DD} ≤ V_{(BR)DSS}, T_J ≤ 150°C
P-Channel I_{SD} ≤ -1.2A, di/dt ≤ 160A/μs, V_{DD} ≤ V_{(BR)DSS}, T_J ≤ 150°C
- ③ Pulse width ≤ 300μs; duty cycle ≤ 2%.
- ④ Surface mounted on FR-4 board, t ≤ 10sec.

N - Channel

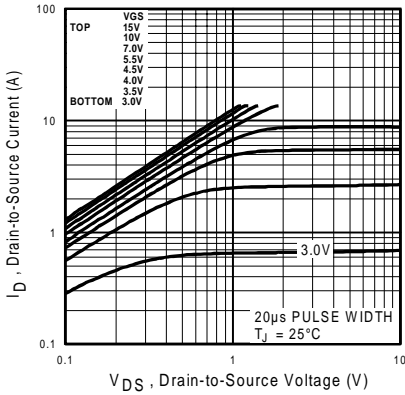

Fig 1. Typical Output Characteristics

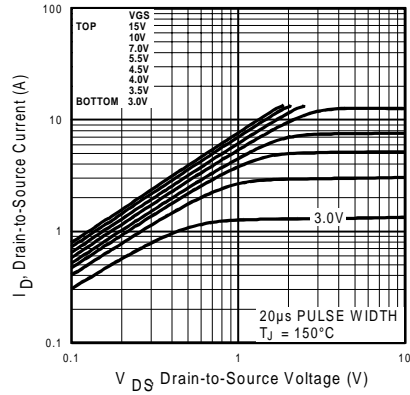

Fig 2. Typical Output Characteristics

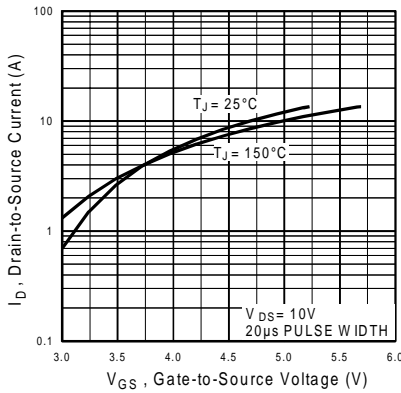

Fig 3. Typical Transfer Characteristics

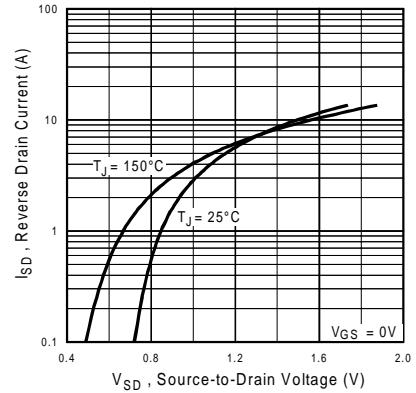

Fig 4. Typical Source-Drain Diode Forward Voltage

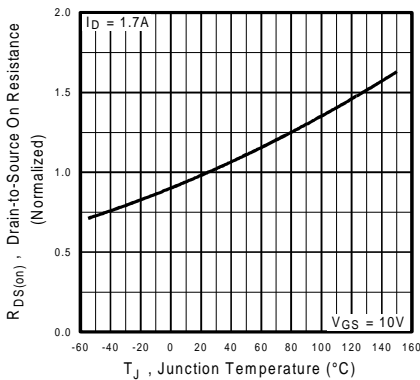

Fig 5. Normalized On-Resistance Vs. Temperature

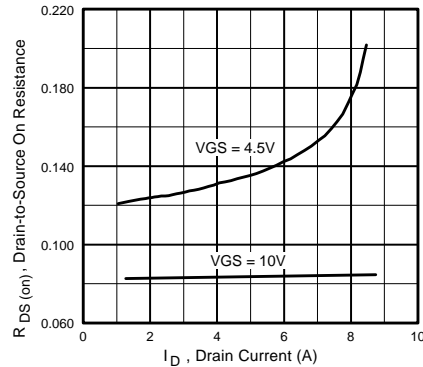

Fig 6. Typical On-Resistance Vs. Drain Current

IRF7509

N - Channel

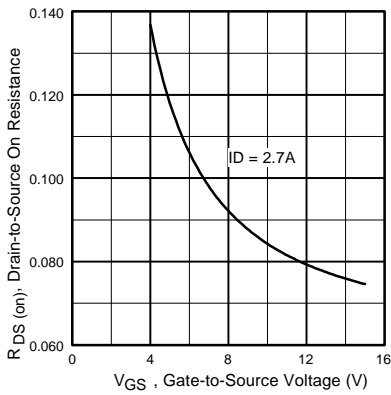

Fig 7. Typical On-Resistance Vs. Gate Voltage

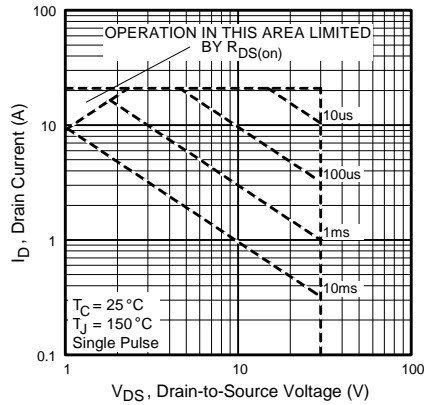

Fig 8. Maximum Safe Operating Area

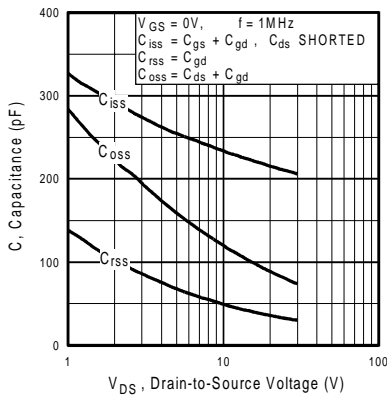

Fig 9. Typical Capacitance Vs. Drain-to-Source Voltage

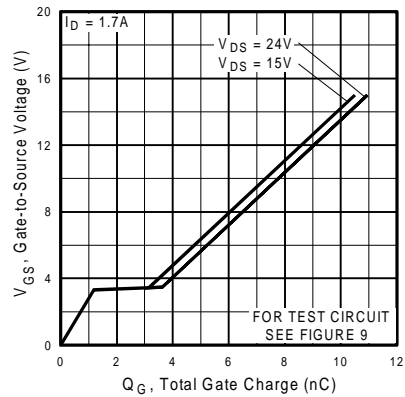

Fig 10. Typical Gate Charge Vs. Gate-to-Source Voltage

P - Channel

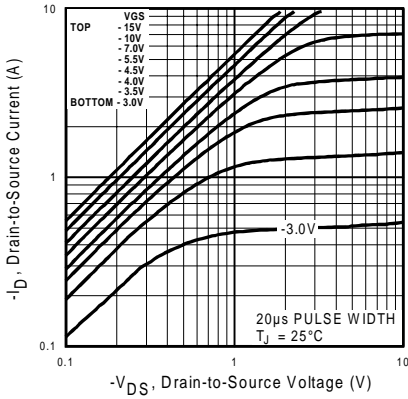

Fig 11. Typical Output Characteristics

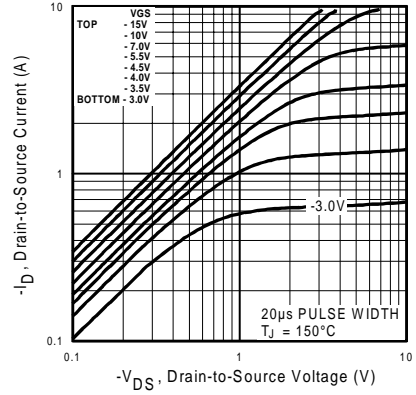

Fig 12. Typical Output Characteristics

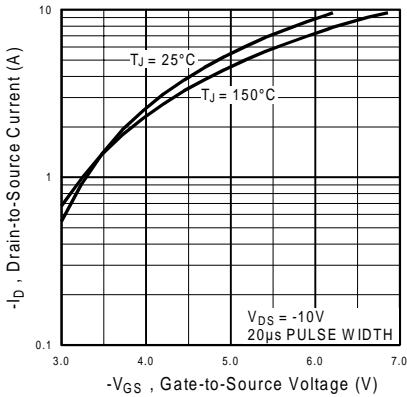

Fig 13. Typical Transfer Characteristics

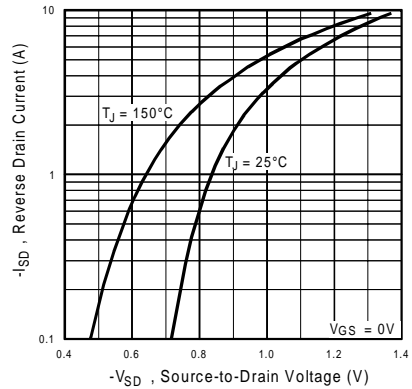

Fig 14. Typical Source-Drain Diode Forward Voltage

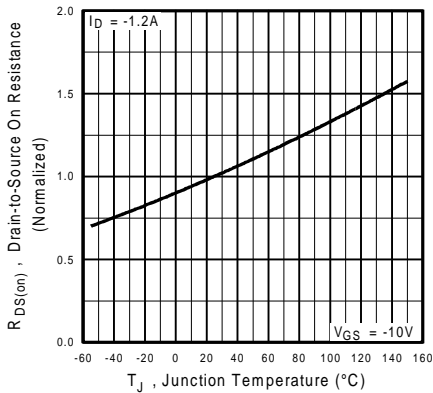

Fig 15. Normalized On-Resistance Vs. Temperature

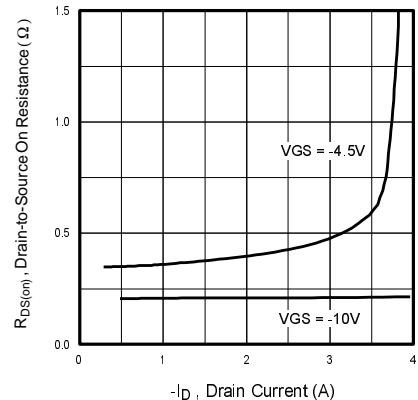

Fig 16. Typical On-Resistance Vs. Drain Current

P - Channel

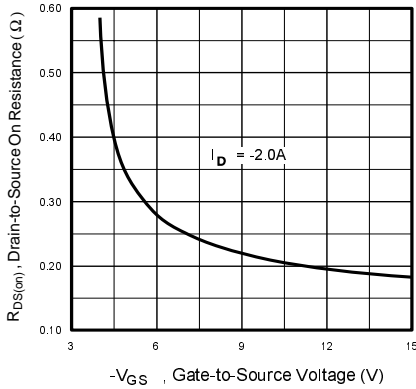

Fig 17. Typical On-Resistance Vs. Gate Voltage

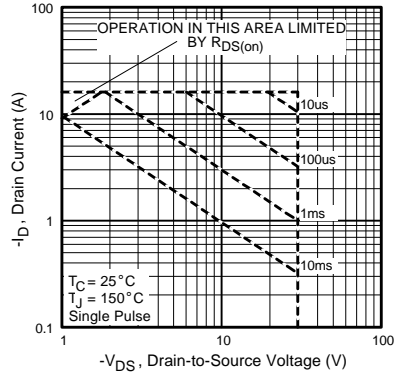

Fig 18. Maximum Safe Operating Area

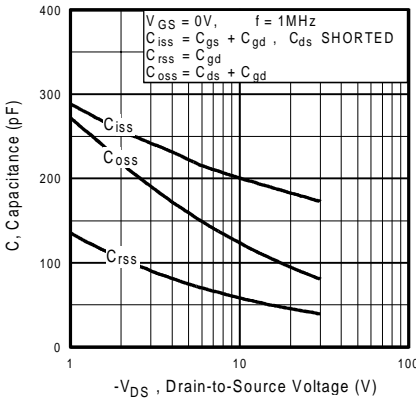

Fig 19. Typical Capacitance Vs. Drain-to-Source Voltage

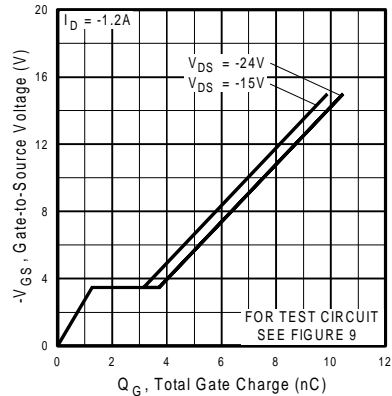

Fig 20. Typical Gate Charge Vs. Gate-to-Source Voltage

N-P - Channel

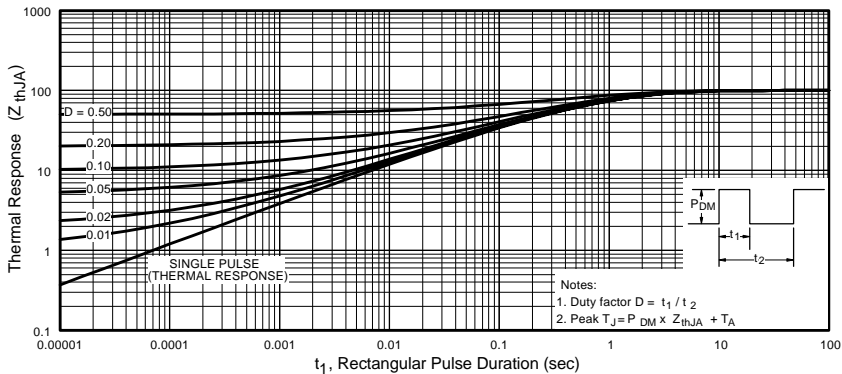
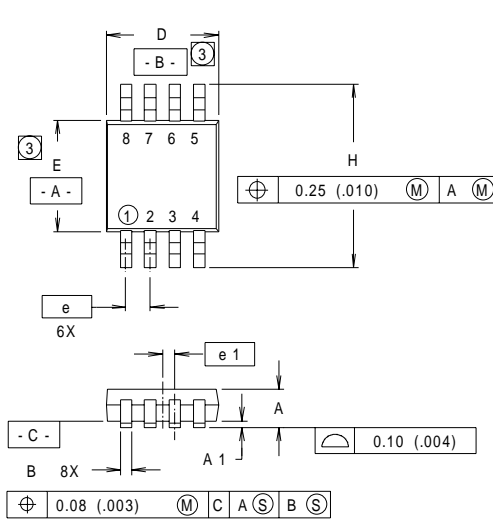

Fig 21. Maximum Effective Transient Thermal Impedance, Junction-to-Ambient

Package Outline

Micro8 Outline

Dimensions are shown in millimeters (inches)



LEAD ASSIGNMENTS

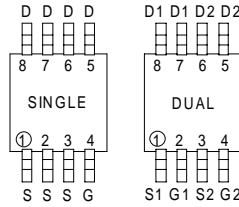

DIM	INCHES		MILLIMETERS	
	MIN	MAX	MIN	MAX
A	.036	.044	0.91	1.11
A1	.004	.008	0.10	0.20
B	.010	.014	0.25	0.36
C	.005	.007	0.13	0.18
D	.116	.120	2.95	3.05
e	.0256 BASIC		0.65 BASIC	
e1	.0128 BASIC		0.33 BASIC	
E	.116	.120	2.95	3.05
H	.188	.198	4.78	5.03
L	.016	.026	0.41	0.66
θ	0°	6°	0°	6°

RECOMMENDED FOOTPRINT

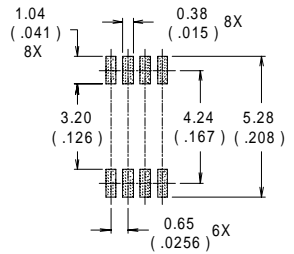

NOTES:

- 1 DIMENSIONING AND TOLERANCING PER ANSI Y14.5M-1982.
- 2 CONTROLLING DIMENSION : INCH.
- 3 DIMENSIONS DO NOT INCLUDE MOLD FLASH.

Part Marking Information

Micro8

EXAMPLE : THIS IS AN IRF7501

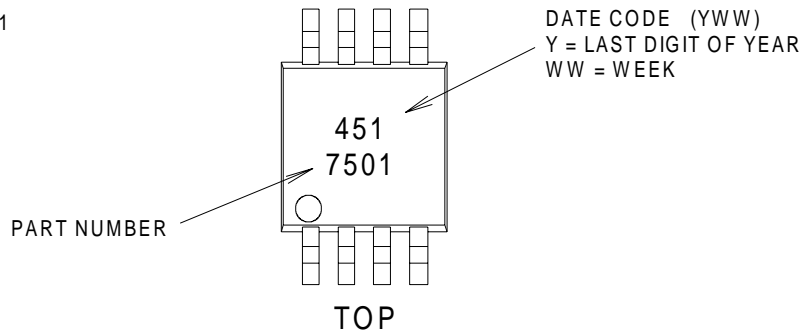

Tape & Reel Information

Micro8

Dimensions are shown in millimeters (inches)

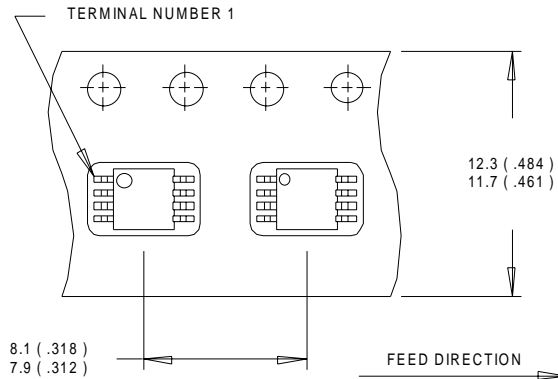

NOTES:

1. OUTLINE CONFORMS TO EIA-481 & EIA-541.
2. CONTROLLING DIMENSION : MILLIMETER.

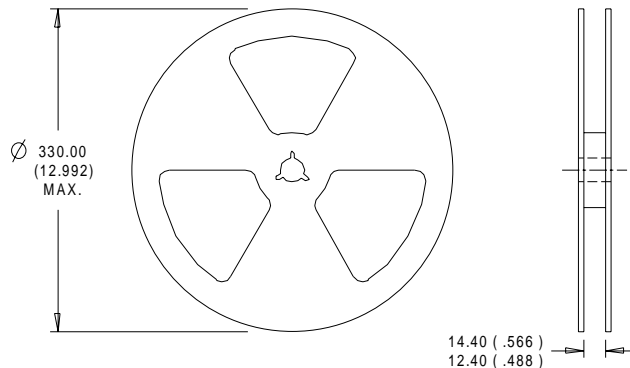

NOTES:

1. CONTROLLING DIMENSION : MILLIMETER.
2. OUTLINE CONFORMS TO EIA-481 & EIA-541.

International
IOR Rectifier

WORLD HEADQUARTERS: 233 Kansas St., El Segundo, California 90245, Tel: (310) 322 3331

IR GREAT BRITAIN: Hurst Green, Oxted, Surrey RH8 9BB, UK Tel: ++ 44 1883 732020

IR CANADA: 15 Lincoln Court, Brampton, Ontario L6T3Z2, Tel: (905) 453 2200

IR GERMANY: Saalburgstrasse 157, 61350 Bad Homburg Tel: ++ 49 6172 96590

IR ITALY: Via Liguria 49, 10071 Borgaro, Torino Tel: ++ 39 11 451 0111

IR FAR EAST: K&H Bldg., 2F, 30-4 Nishi-Ikebukuro 3-Chome, Toshima-Ku, Tokyo Japan 171 Tel: 81 3 3983 0086

IR SOUTHEAST ASIA: 1 Kim Seng Promenade, Great World City West Tower, 13-11, Singapore 237994 Tel: ++ 65 838 4630

IR TAIWAN: 16 Fl. Suite D. 207, Sec. 2, Tun Haw South Road, Taipei, 10673, Taiwan Tel: 886-2-2377-9936

<http://www.irf.com/> Data and specifications subject to change without notice. 12/98